



Amana® 14 cu. ft. Top-Freezer Refrigerator with Flexible Storage Options

ART104TFDW

Available Finishes/Colours



ART104TFDW
White



ART104TFDB
Black

Stock up on the foods you love with this 14 cu. ft. top-freezer refrigerator. You can easily store it all with a full-width crisper bin, gallon door bins, compartments and shelves that fit your storage needs. You'll be able to easily change temperature settings in the door without having to reach to the back of the refrigerator, thanks to up-front temperature control. Plus, you can look forward to saving energy and money with our lowest-energy-consuming refrigerator ever.

Dimensions

Depth	30
Height	62 7/8
Width	28

AHAM Volumes And Shelf Area

Freezer Volume (Cu Ft)	3.87
Refrigerator Volume (Cu Ft)	10.46

Configuration and Overview

Counter Depth	No
Levelers	2 Black

Details

Counter Depth	No
Door Style	Flat

Exterior

Cabinet Color	White
Cabinet Finish	Textured
Door Color	White
Door Finish	Textured

Exterior

Handle Material	Plastic
Door Opening	Right
Handle Type	Pocket Handle
Door Style	Flat
Handle Color	White
Levelers	2 Black
Wheels	4-Natural
Hidden Hinge	No
Reversible Door	Yes

Misc.

Home Delivery	Yes
Will Call	Yes

Appearance

Cabinet Finish	Textured
Handle Material	Plastic
Door Style	Flat





Top Features

Optional Automatic Icemaker Kit

Dairy Bin

Full-Width Crisper Drawer

Manuals & Literature:

-  [Dimension Guide](#)
-  [Energy Guide](#)
-  [Installation Guide](#)
-  [Use and Care Guide](#)
-  [Warranty Information](#)

Amana[®] Top Mount Refrigerator

PRODUCT MODEL NUMBERS

ART104TFD
ART106TFD
ART316TFD

Electrical: A 115-volt, 60-Hz, AC-only, 15- or 20-amp fused, grounded electrical supply is required. It is recommended that a separate circuit serving only your refrigerator be provided. Use an outlet that cannot be turned off by a switch. Do not use an extension cord.

Water: A cold water supply with water pressure between 30 and 120 psi (207 and 827 kPa) is required to operate ice maker and water dispenser. If you have questions about your water pressure, call a licensed, qualified plumber.

IMPORTANT: The pressure of the water coming out of a reverse osmosis system going to the water inlet valve of the refrigerator needs to be between 30 and 120 psi (207 and 827 kPa).

Reverse Osmosis Water Supply: If a reverse osmosis water filtration system is connected to your cold water supply, the water pressure to the reverse osmosis system needs to be a minimum of 40 to 60 psi (276 to 414 kPa).

PRODUCT DIMENSIONS

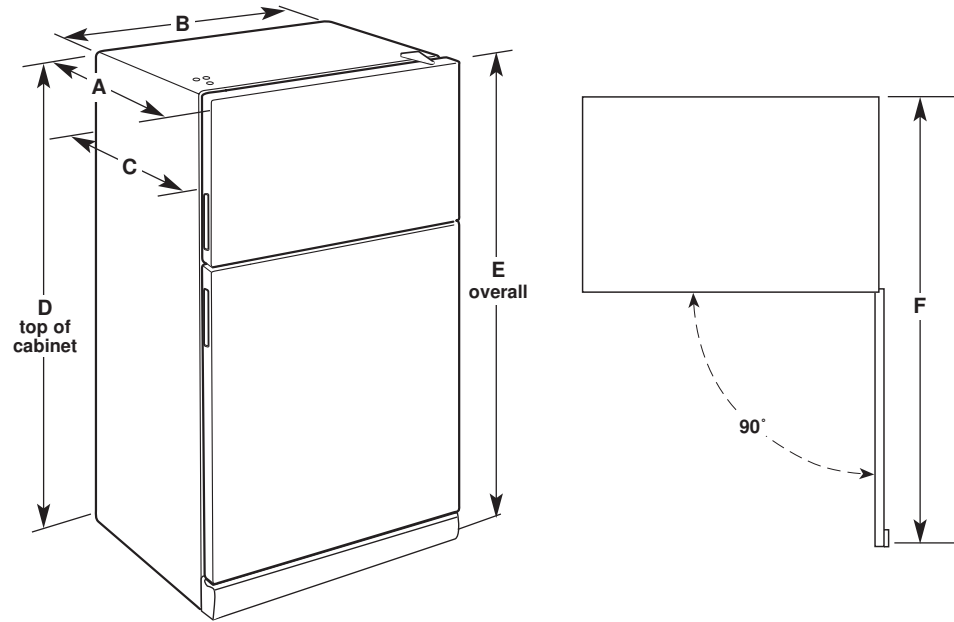

Model Number	Model Size	Reversible Door	Depth - With Door "A"	Cab. Width "B"	Depth - Cabinet Only "C"	Cab. Height "D"	Overall Height "E"	Depth Door Open 90° "F"
ART104TFD	14.3 cu. ft.	Yes	30" (76.2 cm)	28" (71.1 cm)	25 1/2" (64 cm)	62 3/4" (158.4 cm)	62 7/8" (159.7 cm)	56 3/4" (144.1 cm)
ART106TFD ART316TFD	16 cu. ft.	Yes	31 1/2" (79.4 cm)	28" (71.1 cm)	25 1/2" (64 cm)	65 3/4" (166 cm)	65 7/8" (167.3 cm)	56 3/4" (144.1 cm)

LOCATION REQUIREMENTS

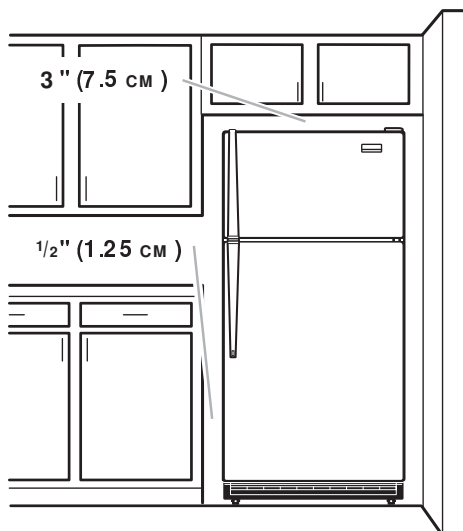

To ensure proper ventilation for your refrigerator, allow for a 1/2" (1.25 cm) space on each side. Allow 3" (7.5 cm) of space between overhead cabinets and refrigerator top. Allow at least 1" (25.40 mm) between back of cabinet and the wall. If your refrigerator has an ice maker, make sure you leave some extra space at the back for the water line connections.

If you are installing your refrigerator next to a fixed wall, leave enough space on the hinge side to allow for the door to swing open.

NOTE: This refrigerator is intended for use in a location where the temperature ranges from a minimum of 55°F (13°C) to a maximum of 110°F (43°C). The preferred room temperature range for optimum performance, which reduces electricity usage and provides superior cooling, is between 60°F (15°C) and 90°F (32°C). It is recommended that you do not install the refrigerator near a heat source, such as an oven or radiator.